

SKU# 07118

PART LIST | LISTE DES PIÈCES | LISTA DE PIEZAS

A x 2

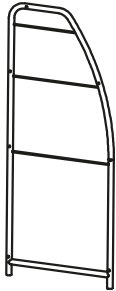

B x 2

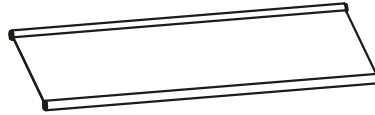

C x 1

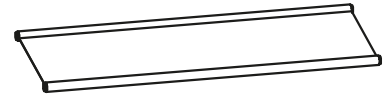

D x 1



E x 1

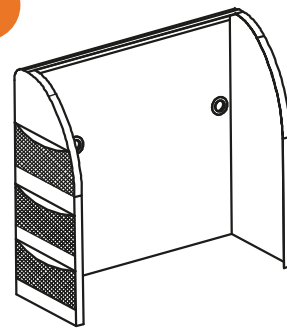

F1 x 5 F2 x 5

F1

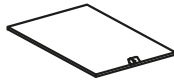

F2

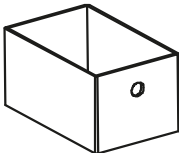

G1 x 3 G2 x 3

G1

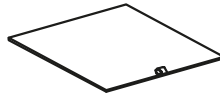

G2

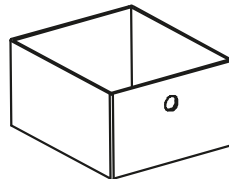

H1 x 3 H2 x 3

H1

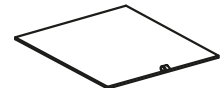

H2

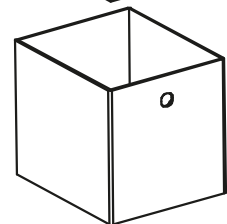

I x 14

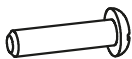

J x 12



K x 2



FOR ASSISTANCE

For English/French assistance please call 1-888-827-4676 (US/Canada) between 8:00am to 4:30pm EST (Monday to Friday) to speak with a Customer Service Representative. For after hours service, please leave a detailed message or email us at info@neatfreak.com

POUR L'ASSISTANCE

Pour obtenir de l'assistance en anglais ou en français, veuillez communiquer avec un représentant du service à la clientèle en composant le 1 888 827-4676 (États-Unis/Canada) du lundi au vendredi, entre 8 h et 16 h 30 (HE). En dehors des heures d'ouverture, veuillez laisser un message détaillé ou envoyer un courriel à l'adresse info@neatfreak.com

ASISTENCIA

Para recibir asistencia en inglés o francés, por favor llame al 1-888-827-4676 (Estados Unidos / Canadá) de 8:00 am a 4:30 pm Hora del Este (de lunes a viernes) para hablar con un representante de servicio al cliente. Para horas fuera de servicio por favor deje un mensaje detallado o un correo electrónico a info@neatfreak.com

Maximum weight capacity 40.8 kg / 90 lb;
Per shelf 13.6 kg / 30 lb
Capacité de poids maximale 40,8 kg / 90 lb;
Par étagère 13,6 kg / 30 lb
Capacidad máxima de peso 40.8 kg / 90 lb;
Por estante 13.6 kg / 30 lb



MADE IN CHINA
FABRIQUÉ EN CHINE
HECHO EN CHINA

NEATFREAK GROUP INC.
Oakville, Ontario, Canada L6L 5L7
info@neatfreak.com
www.neatfreak.com

neatfreak!
THE HOME ORGANIZATION COMPANY®

SKU# 07118

ASSEMBLY INSTRUCTIONS | INSTRUCCIONES DE MONTAGE | INSTRUCCIONES DE MONTAJE

1

A x 2 B x 2 C x 1 D x 1
I x 14 J x 12 K x 2

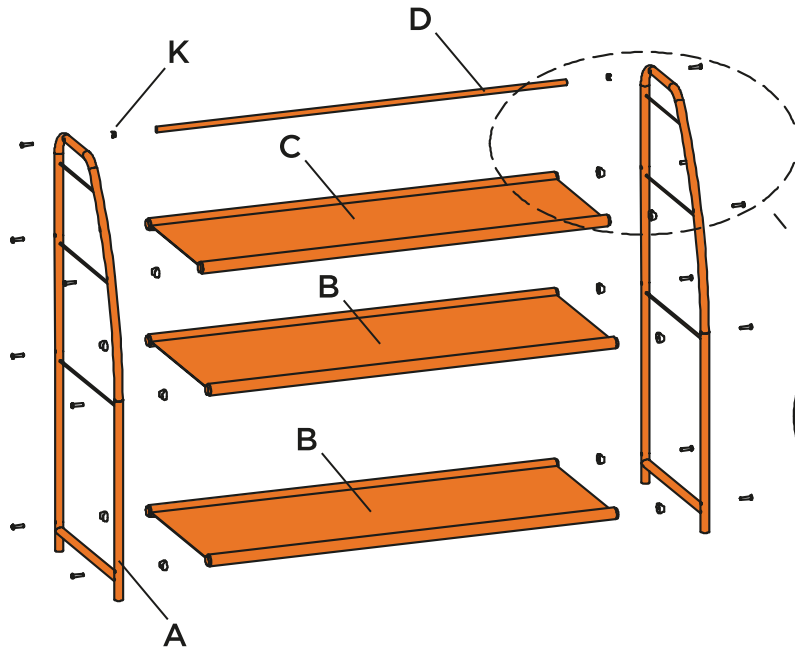

Screwdriver required (not included)
Destornillador requerido (no incluido)
Turnavis requis (no incluido)

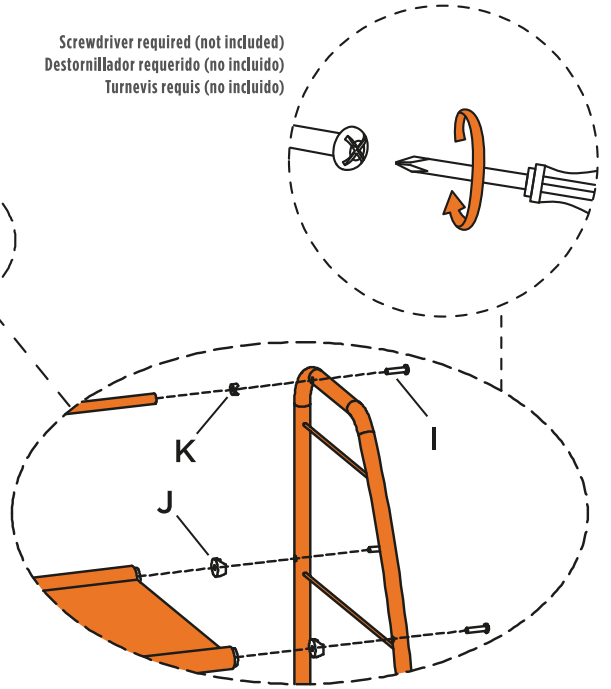

2

F1 x 5 F2 x 5 G1 x 3
G2 x 3 H1 x 3 H2 x 3

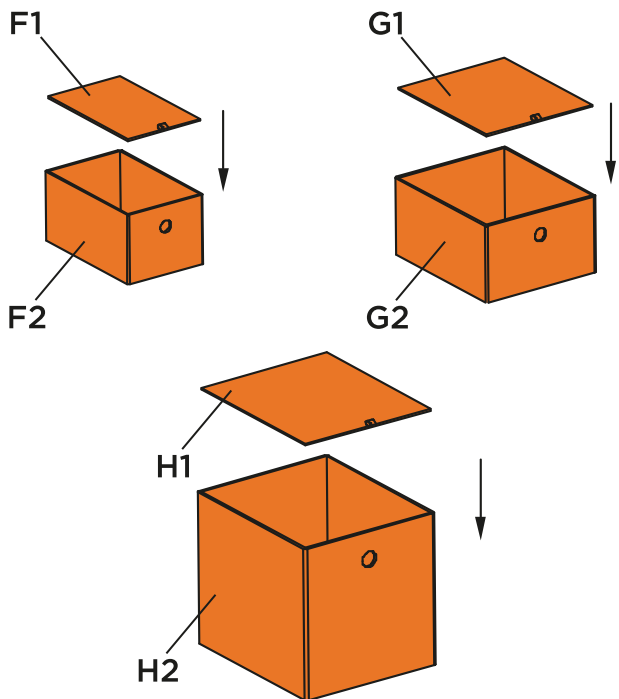

3

E x 1 F x 5
G x 3 H x 3

