

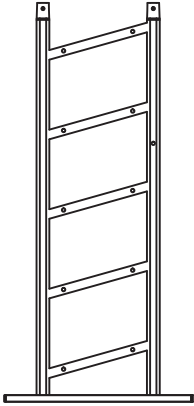

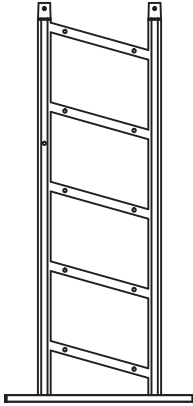

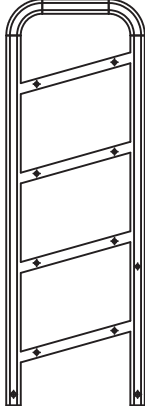
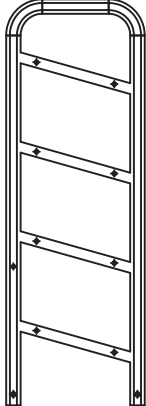
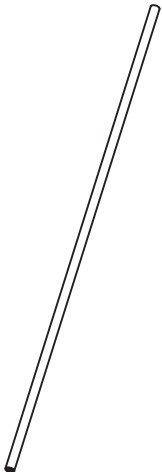
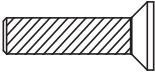
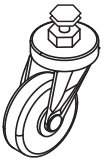
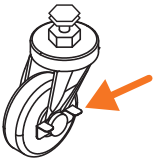

SKU# 05002

PART LIST | LISTE DES PIÈCES | LISTA DE PIEZAS

<p>A1 x 1</p> 	<p>B1 x 1</p> 	<p>A2 x 1</p> 	<p>B2 x 1</p> 
<p>C x 18</p> 	<p>D x 36</p> 	<p>E x 2</p> 	<p>F x 2</p> 
	<p>G1 x 1</p> 	<p>G2 x 1</p> 	<p>H x 1</p> 
<p>I x 1</p> 	<p>J x 4</p> 	<p>K x 1</p> 	

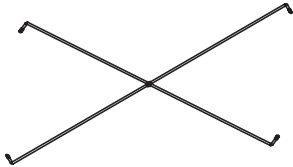
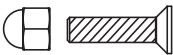
FOR ASSISTANCE

For English/French assistance please call 1-888-827-4676 (US/Canada) between 8:00am to 4:30pm EST (Monday to Friday) to speak with a Customer Service Representative. For after hours service, please leave a detailed message or email us at info@neatfreak.com

POUR L'ASSISTANCE

Pour obtenir de l'assistance en anglais ou en français, veuillez communiquer avec un représentant du service à la clientèle en composant le 1 888 827-4676 (États-Unis/Canada) du lundi au vendredi, entre 8 h et 16 h 30 (HE). En dehors des heures d'ouverture, veuillez laisser un message détaillé ou envoyer un courriel à l'adresse info@neatfreak.com

ASISTENCIA

Para recibir asistencia en inglés o francés, por favor llame al 1-888-827-4676 (Estados Unidos / Canadá) de 8:00 am a 4:30 pm Hora del Este (de lunes a viernes) para hablar con un representante de servicio al cliente. Para horas fuera de servicio por favor deje un mensaje detallado o un correo electrónico a info@neatfreak.com

Maximum weight capacity 45.3 kg / 100 lb
Capacité de poids maximale 45,3 kg / 100 lb
Capacidad máxima de peso 45.3 kg / 100 lb



MADE IN CHINA
FABRIQUÉ EN CHINE
HECHO EN CHINA

NEATFREAK GROUP INC.
Oakville, Ontario, Canada L6L 5L7
info@neatfreak.com
www.neatfreak.com

neatfreak!
THE HOME ORGANIZATION COMPANY®

SKU# 05002

ASSEMBLY INSTRUCTIONS | INSTRUCTIONS DE MONTAGE | INSTRUCCIONES DE MONTAJE

1

A1 x 1 B1 x 1 C x 10
D x 20 K x 1

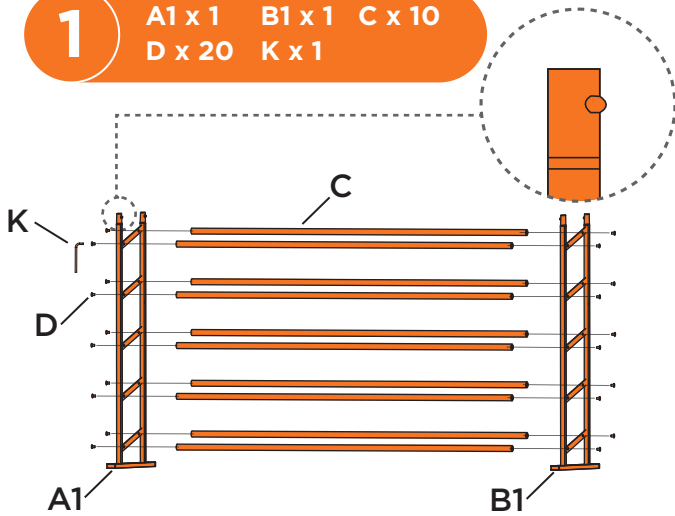

2

E x 2 F x 2
G1 x 1 H x 1

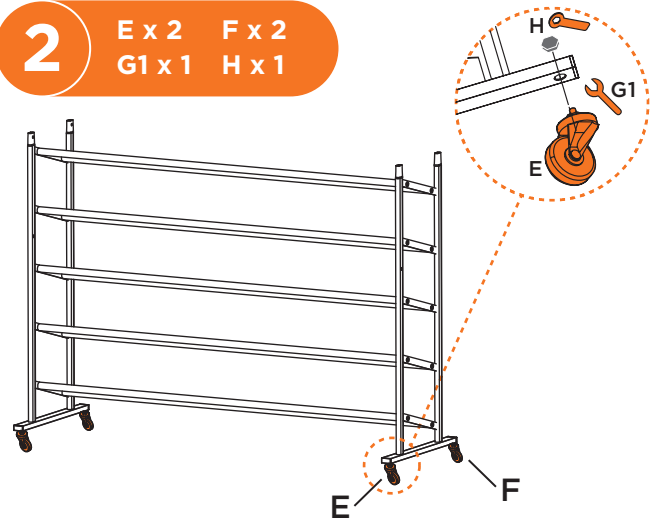

3

A2 x 1 B2 x 1 C x 8
D x 16 K x 1

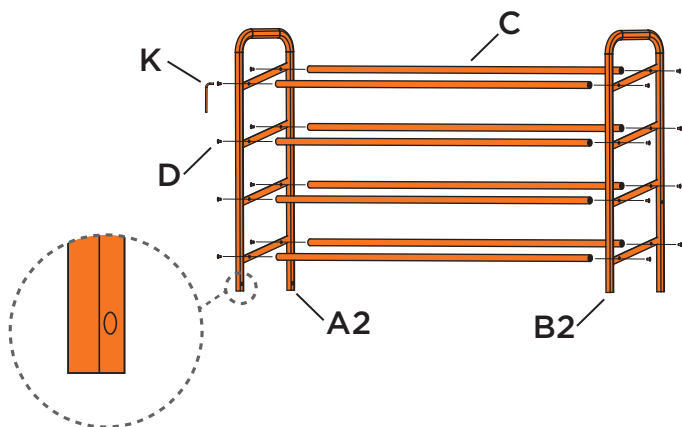

4

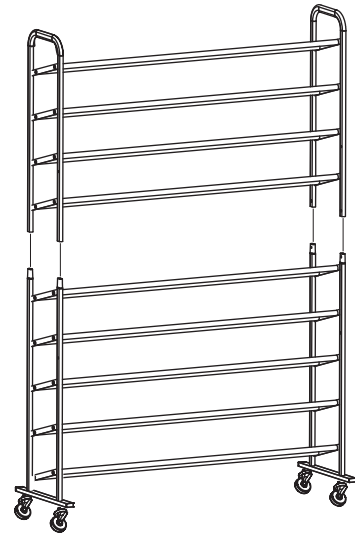

5

G2 x 1 I x 1
J x 4 K x 1

